

PRODUCT FEATURES

- Low Forward Voltage
- High Surge Current Capability
- Low Leakage Current
- Low Inductance Package

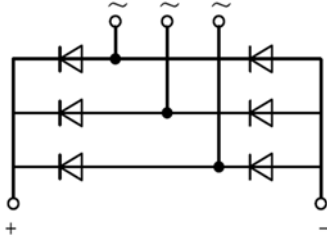

APPLICATIONS

- Field Supply For DC Motors
- Line Rectifiers For Transistorized AC Motor Controllers
- Non-controllable Rectifiers For AC/DC Converter
- UL:E332185



Module Type

Module Type	V_{RRM} Repetitive Peak Reverse Voltage	V_{RSM} Non-Repetitive Peak Reverse Voltage	Unit
MMD70E160X	1600	1700	V

ABSOLUTE MAXIMUM RATINGS($T_C=25^{\circ}C$ unless otherwise specified)

Symbol	Parameter/Test Conditions		Values	Unit	
I_D	Output Current(D.C.)	Three phase, full wave, $T_C=95^{\circ}C$	70	A	
I_{FSM}	Non-Repetitive Surge Forward Current	1/2 cycle, 50HZ, peak value, $T_J=45^{\circ}C$	700		
		1/2 cycle, 60HZ, peak value, $T_J=45^{\circ}C$	750		
I^2t	For Fusing	1/2 cycle, 50HZ, peak value, $T_J=45^{\circ}C$	2.45	KA ² S	
		1/2 cycle, 60HZ, peak value, $T_J=45^{\circ}C$	2.33		
P_D	Power Dissipation		690	W	
T_J	Junction Temperature		-40 to +150	$^{\circ}C$	
T_{STG}	Storage Temperature Range		-40 to +125	$^{\circ}C$	
V_{ISO}	Isolation Breakdown Voltage	AC, 50Hz(R.M.S), $t=1$ minute	3000	V	
Torque	Module to Sink	Recommended (M5)	2.5~5	Nm	
Torque	Module Electrodes	Recommended (M5)	2.5~5	Nm	
R_{thJC}	Junction to Case Thermal Resistance		per diode	1.1	K/W
			per module	0.18	
Weight			150	g	

MacMic Science & Technology Co., Ltd.

Add: #18, Hua Shan Zhong Lu, New District, Changzhou City, Jiangsu Province, P. R. of China

Tel.: +86-519-85163708 Fax: +86-519-85162291 Post Code: 213022 Website: www.macmicst.com

MMD70E160X

ELECTRICAL CHARACTERISTICS ($T_C=25^\circ\text{C}$ unless otherwise specified)

Symbol	Parameter/Test Conditions	Min.	Typ.	Max.	Unit	
I_{RM}	Maximum Reverse Leakage Current			$V_R = V_{RRM}$	0.5	mA
				$V_R = V_{RRM}, T_J = 125^\circ\text{C}$	10	
V_F	Forward Voltage Drop			$I_F=70\text{A}$	1.35	V
V_{TO}	For power loss calculations only, $T_J = 125^\circ\text{C}$				0.95	V
r_T					4.7	m Ω

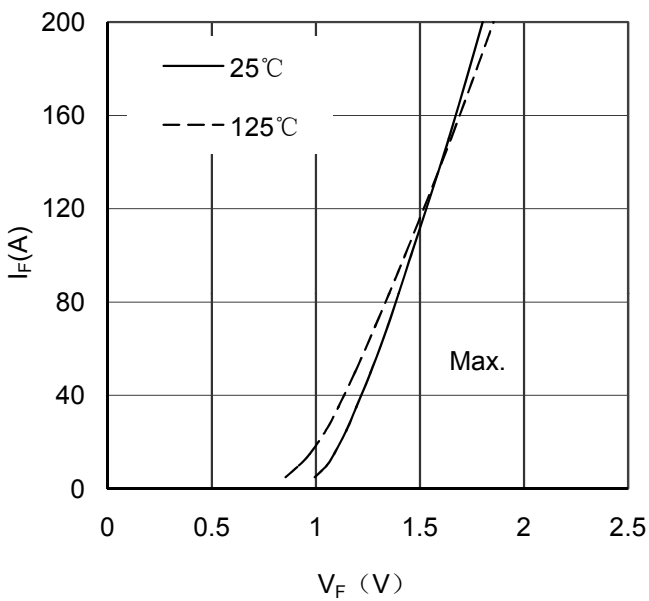

Figure 1. Forward Voltage Drop vs Forward Current

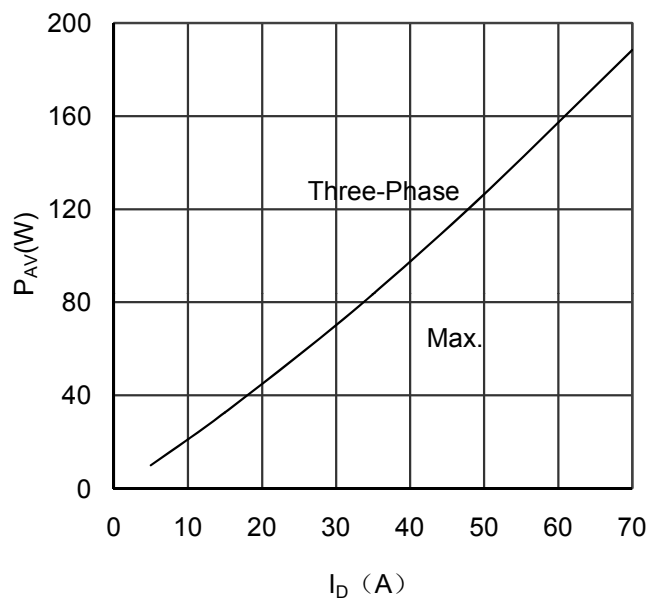

Figure 2. Power dissipation vs Output Current

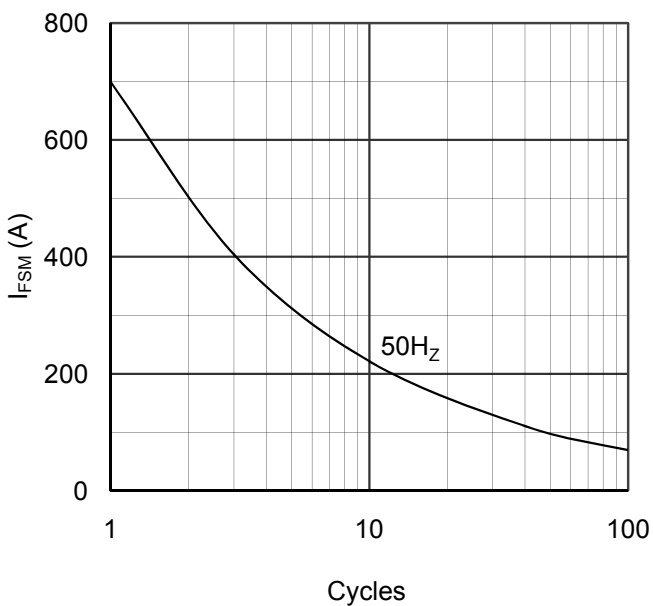

Figure 3. Max Non-Repetitive Forward Surge Current

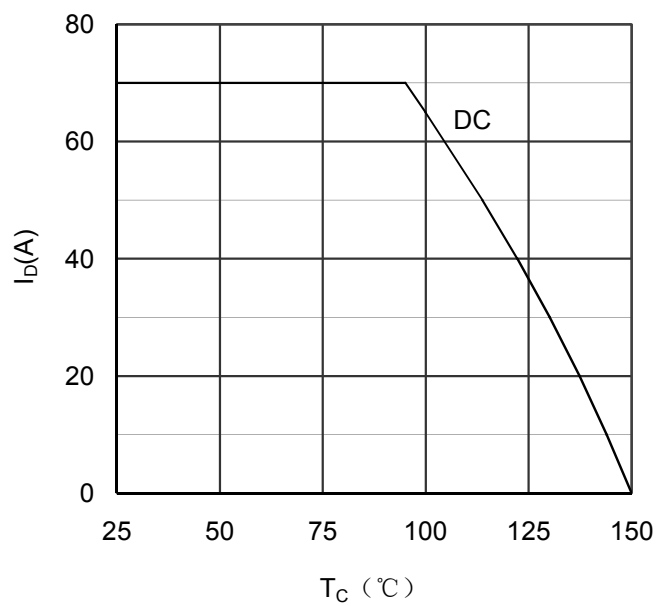
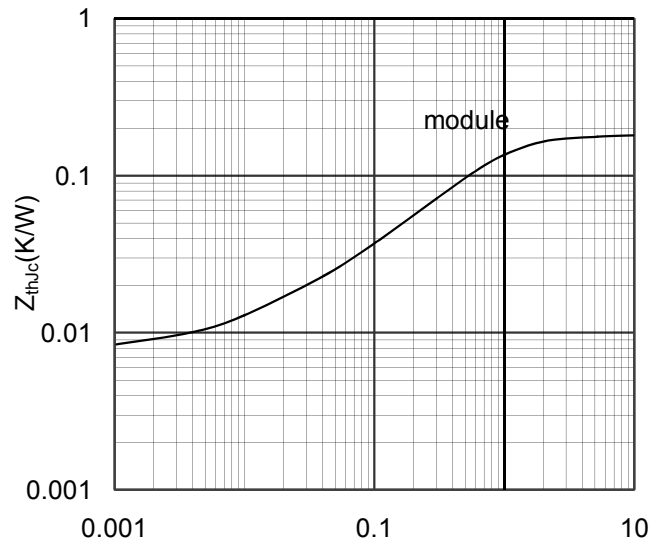
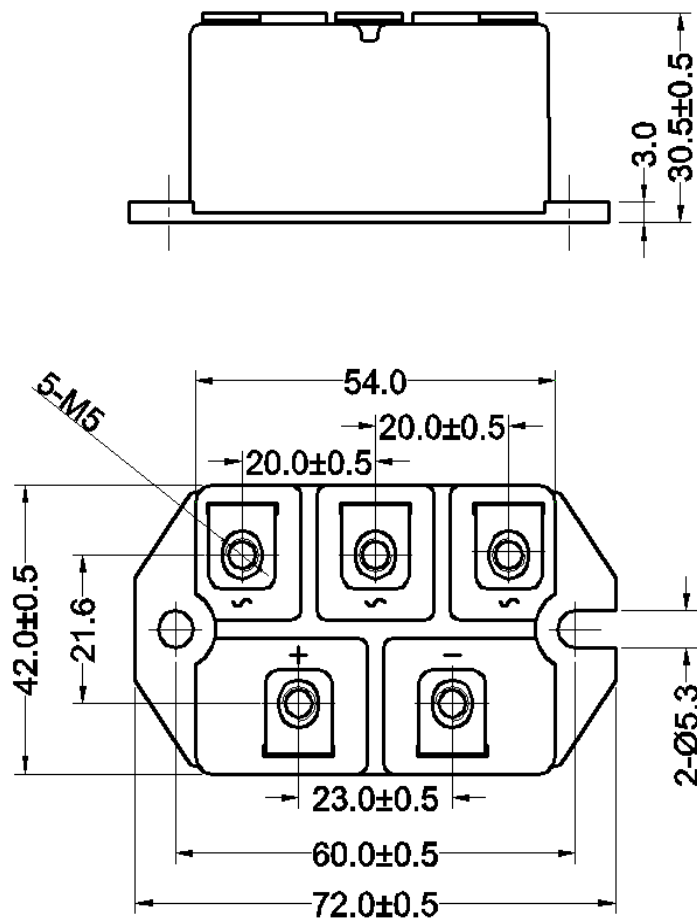

Figure 4. Output current vs Case temperature



Rectangular Pulse Duration(S)
Figure 5. Transient Thermal Impedance



Dimensions in (mm)
Figure 6. Package Outline